

3.6864 MEG HZ.

U21  
OSC.  
CLOCK  
CRYSTAL

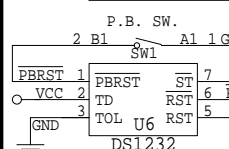
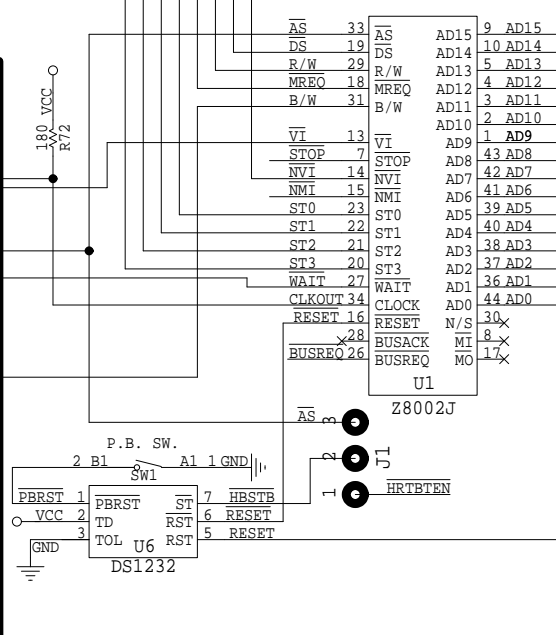
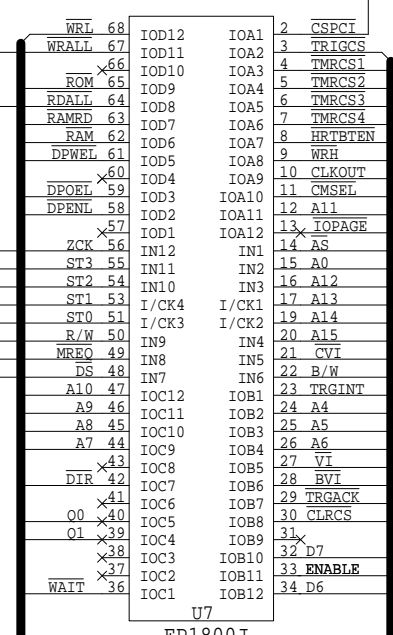
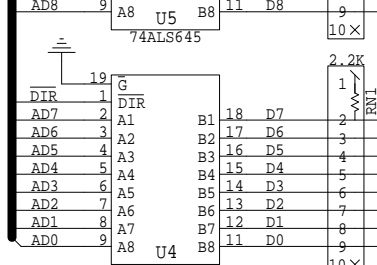
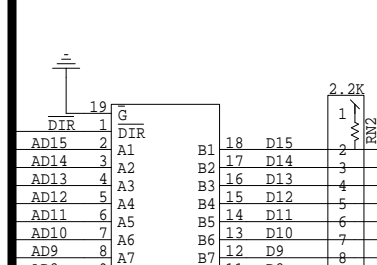
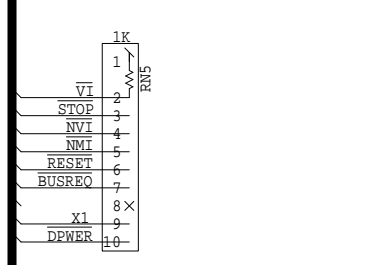
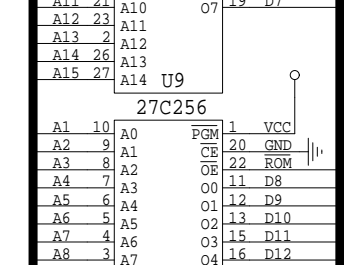
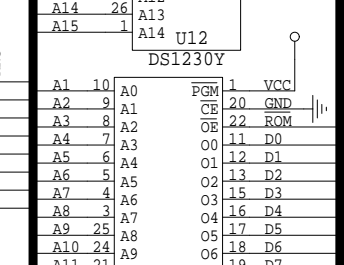
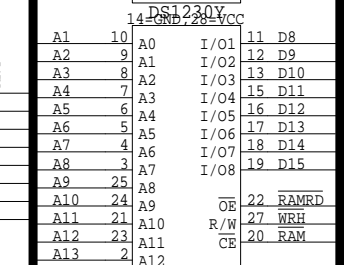
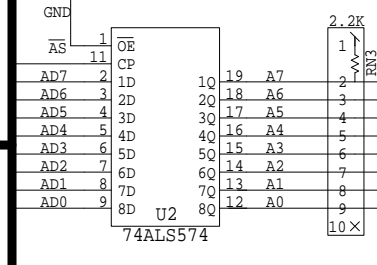
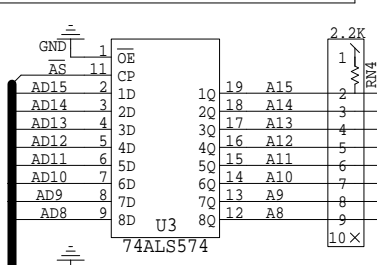
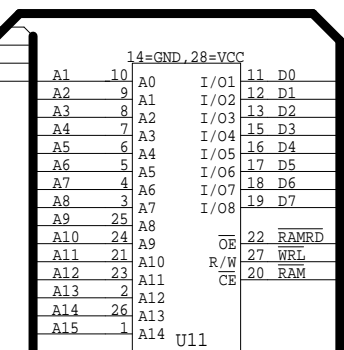
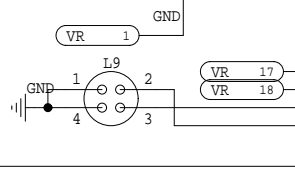
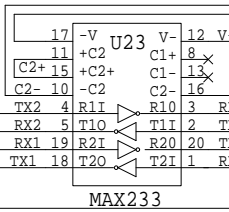
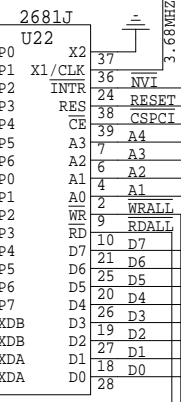

U8  
OSC.  
CLOCK  
CRYSTAL

10 MEG HZ OSC.

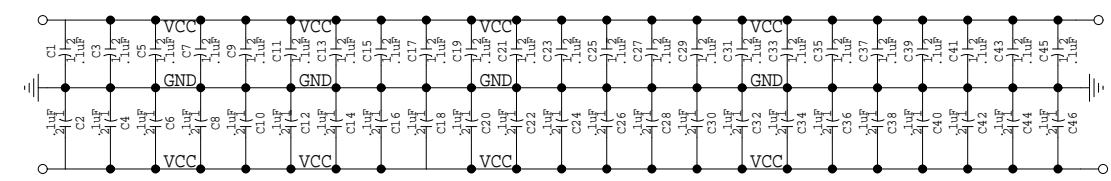

BYPASS CAPS

01

DRAWN A. LEGAN		DATE 9/6/90	C1091 PROCESSOR	
CHECKED A1 Legan		5/20/93	SIZE D	DWG. NO. 2280-ED-172888
ISSUED			SCALE	REV. B
			SHEET 01 OF 03	

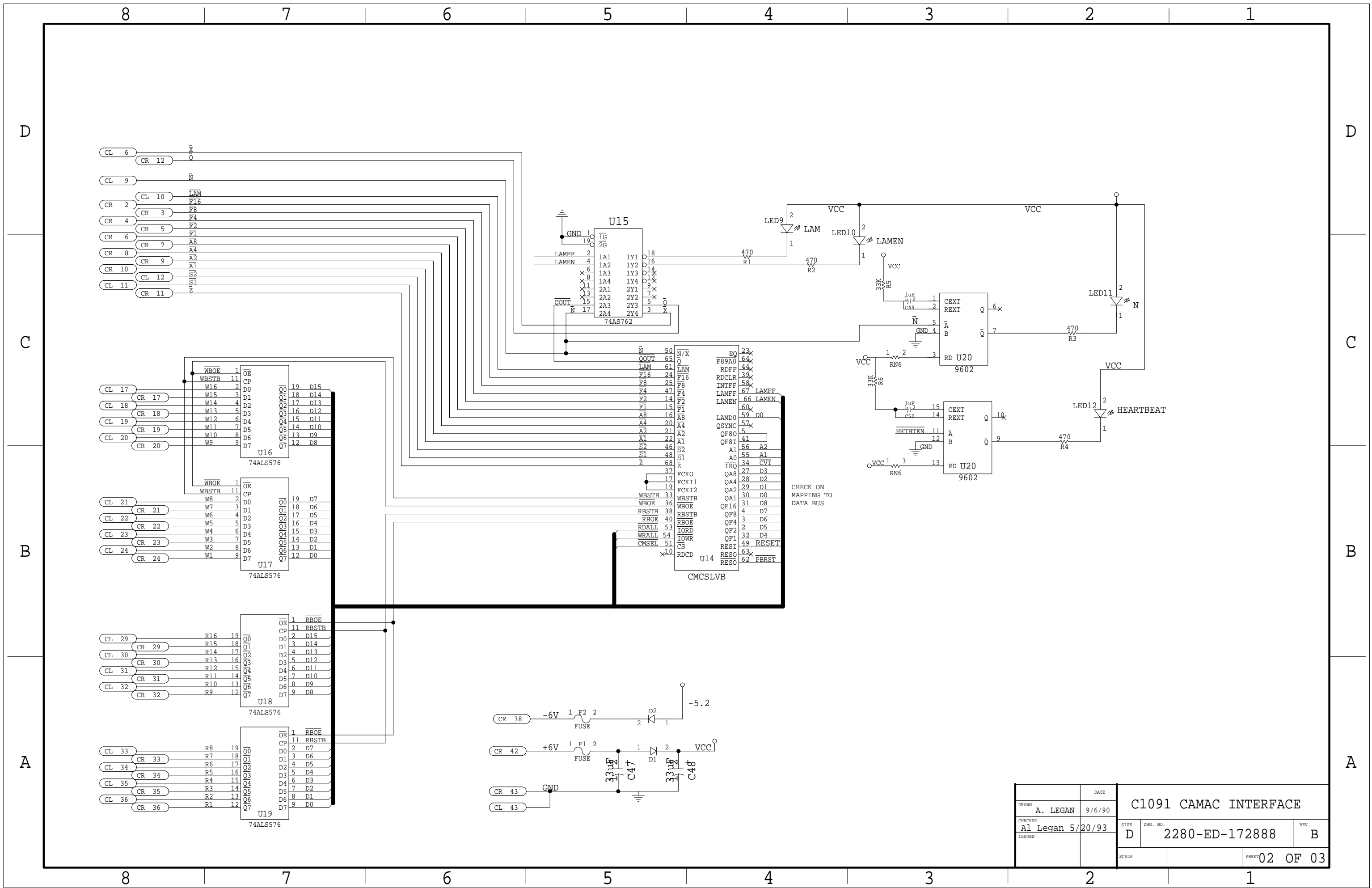

DRAWN A. LEGAN		DATE 9/6/90	C1091 CAMAC INTERFACE	
CHECKED Al Legan 5/20/93		ISSUED	SIZE D	DWG. NO. 2280-ED-172888
			SCALE	REV. B
			SHEET 02 OF 03	

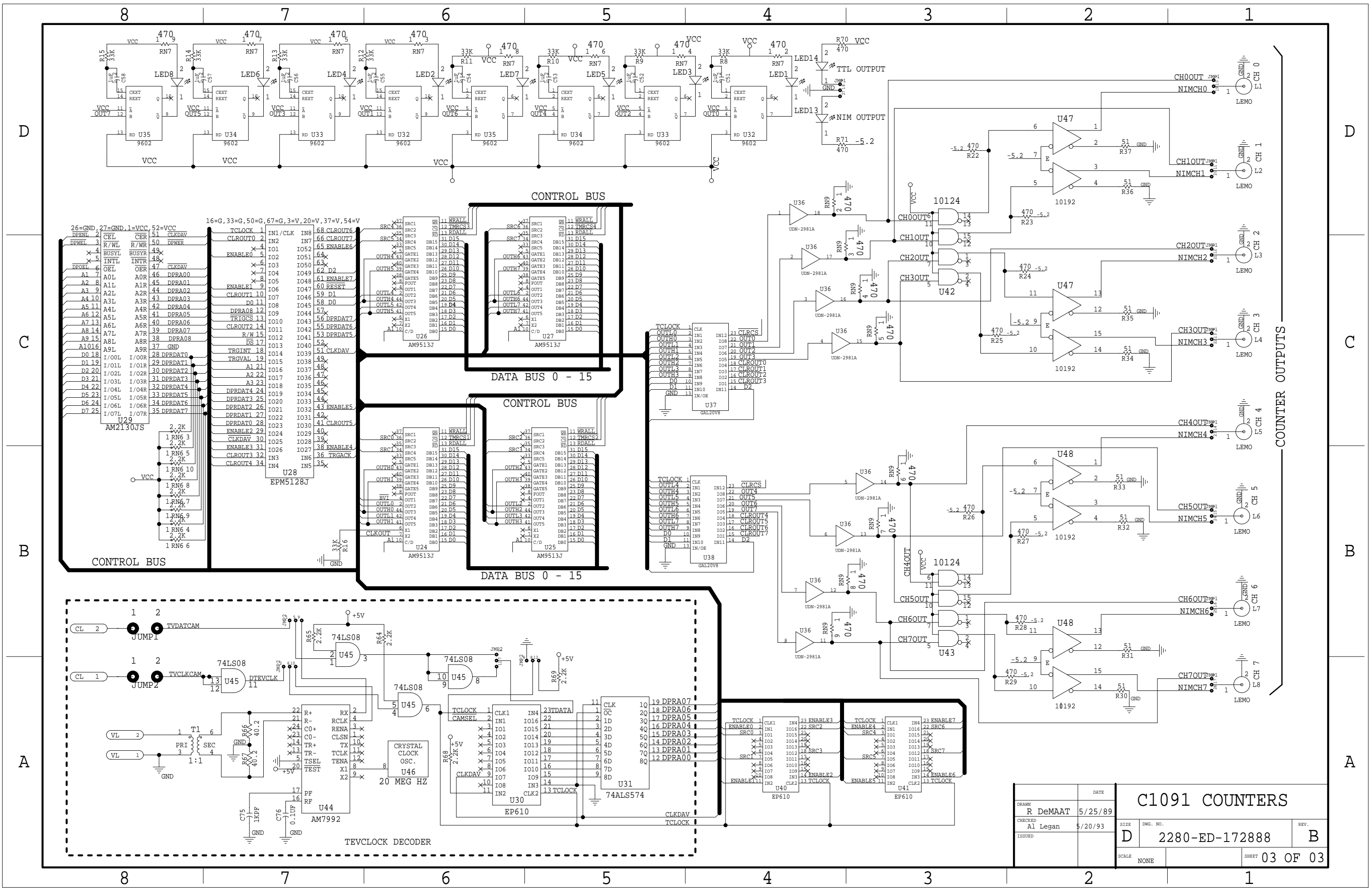

DRAWN		DATE		C1091 COUNTERS	
R DeMAAT		5/25/89			
CHECKED		SIZE		DWG. NO.	
Al Legan		D		2280-ED-172888	
ISSUED		SCALE		SHEET	
		NONE		03 OF 03	